

PLB60B

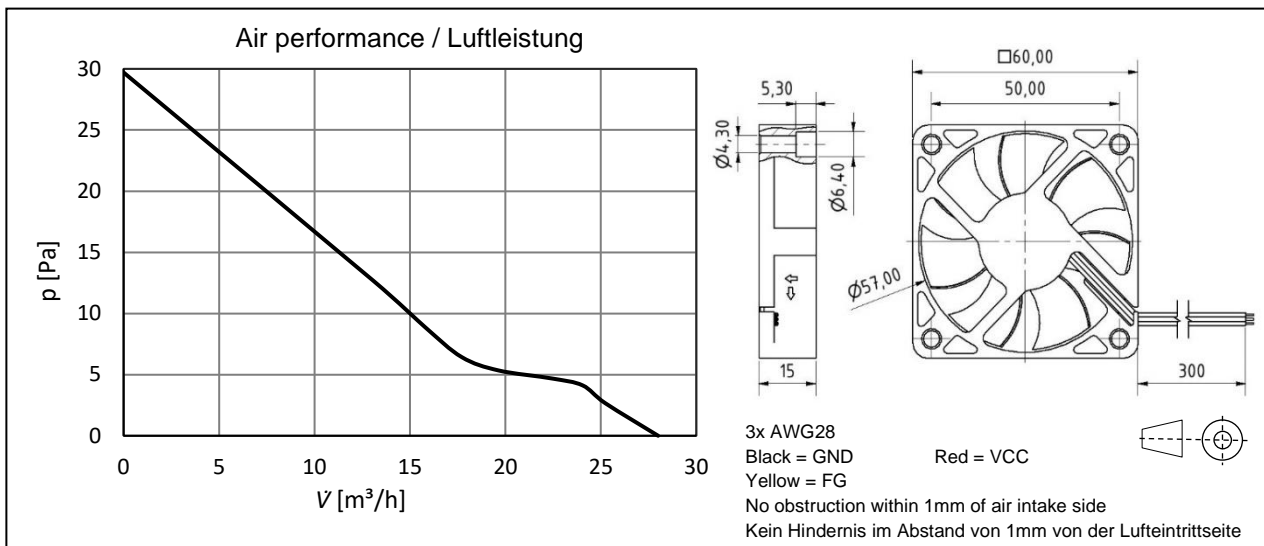

| | PLB60B05SE34A PLB60B05FSE35A | PLB60B12SE32A PLB60B12FSE33A | PLB60B24SE30A PLB60B24FSE31A |
|---|--|---------------------------------|---------------------------------|
| Safety Approvals / Zertifizierungen | CE  | | |
| U [VDC] | 4.5 ... 5 ... 5.5 | 10.8 ... 12 ... 13.2 | 21.6 ... 24 ... 26.4 |
| I _{typ} [mA] | 230 | 90 | 50 |
| I _{max} [mA] | 430 | 210 | 130 |
| V _{max} [l/min – m³/h] | 460 – 28 | | |
| p _{max} [Pa – mmH ₂ O] | 29.7 – 3.0 | | |
| Noise / Geräusch (typ.)* [dB(A)] | 31 | | |
| RPM* [min ⁻¹] | 4000 | | |
| Signal / FG (PLB60BxxF...) [pulses per revolution] | 2 | | |
| PWM [VDC] | - | | |
| Temp. [°C] | -10 ... +70 | | |
| Motor protection / Motorschutz | IC | | |
| L10/MTTF @ 40°C [h] | 70000/350000 | | |
| Bearing / Lagersystem | Ball bearing / Kugellager | | |
| Weight / Gewicht [g] | 34 | | |

* Noise and rotation speed are subject to deviations due to tolerance.
Geräusch und Drehzahl unterliegen toleranzbedingten Abweichungen.

• ORDER INFORMATION / BESTELLDATEN

| | |
|----------------|-----------|
| PLB60B05SE34A | 111111754 |
| PLB60B05FSE35A | 111111744 |
| PLB60B12SE32A | 111111753 |
| PLB60B12FSE33A | 111111745 |
| PLB60B24SE30A | 111111680 |
| PLB60B24FSE31A | 111111742 |

• Technical changes without notice • 05.01.2021
• Technische Änderungen vorbehalten

PLB60B



PLB60B





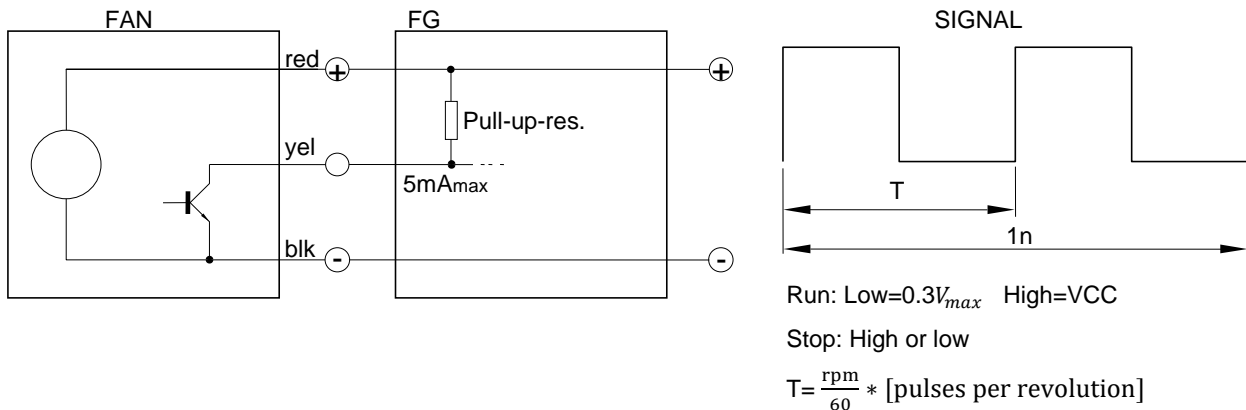

• FG / Tacho

IMPORTANT: The pulse output is not protected against short circuit and must not be connected to GND or VCC without series resistor. A pull-up-resistor is needed. Insulate not used pulse output!

Wichtig: Der Tachoaussgang ist nicht gegen Kurzschluss gesichert und darf ohne Vorwiderstand nicht an GND oder VCC angeschlossen werden. Ein Pull-up-Widerstand wird benötigt. Nicht benutzten Tachoaussgang isolieren!



• ACCESSORIES / ZUBEHÖR

| | | | | |
|---|---|---|---|---|
|  |  |  |  |  |
| | LFGFSB | FG | FM | LM |
| Cable assembly | Dust filter / Fan guard | Metal fan guard | EMC metal filter | Elastic fastening sleeves |
| Konfektionierung | Staubschutzfilter / Fingerschutzgitter | Fingerschutzgitter | EMV Filterrahmen | Lüftermanschette |

• Technical changes without notice • 05.01.2021
 • Technische Änderungen vorbehalten